



Cover 1:
Cord Navy

Cover 2:
Rayleigh Midnight

Dark Wood Feet

Dream Collection

Colours represented are to be used as a guide only.
Please refer to manufacturers swatch for a more accurate colour match.

Please note that colour shadings can vary slightly from each roll of fabric.
We cannot guarantee a precise match to these samples or between cut lengths and upholstered goods.

Extra Flex[®]
Soft, Supportive Seating

Dream COVER GUIDE - STANDARD BACK

Please use this guide when ordering the following pieces to clarify cover options.

Corner Group: LH2, COR, RH1

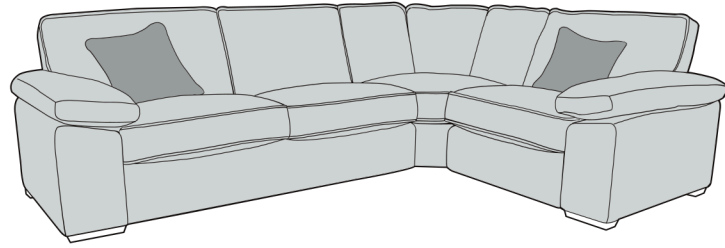

Corner Group: LH1, COR, RH2

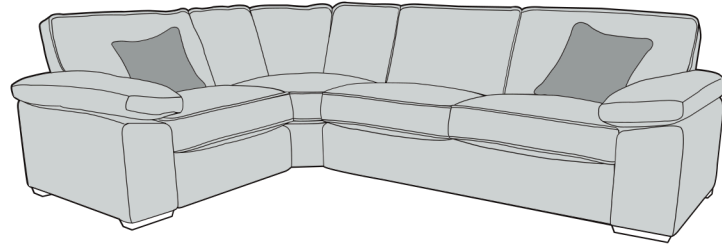

Corner Group: LH2, COR, RH2

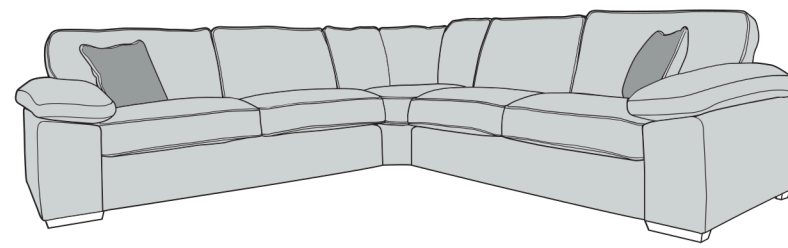

Corner Group: LH2, COR, R2V+VP

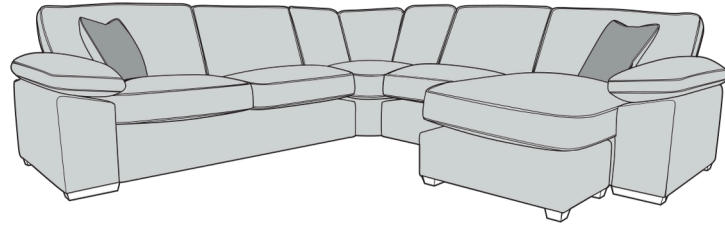

Corner Group: L2V+VP, COR, RH2

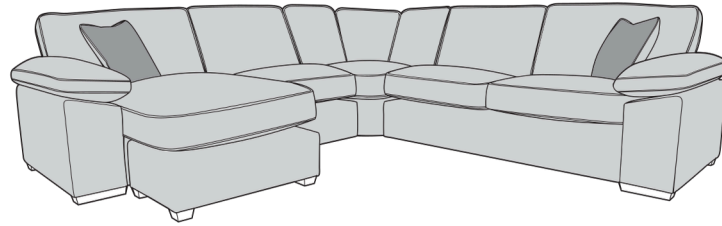

Corner Group: LH1, COR, RH1

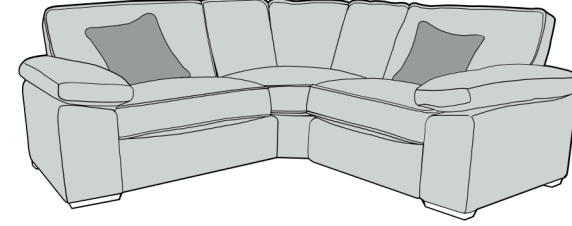

Chaise Sofa: 3RV, RFV

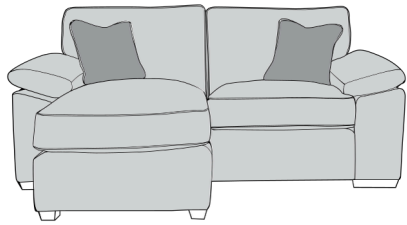

Armless Unit (ALU)

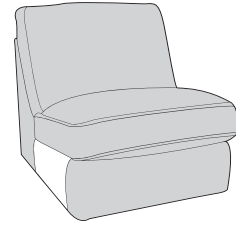

3 Seater Sofa (3ST)

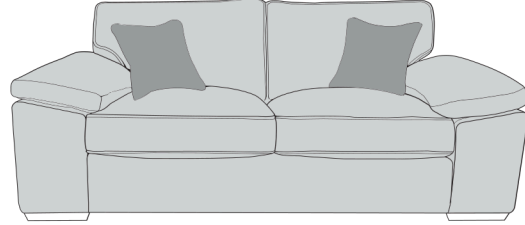

2 Seater Sofa (2ST)

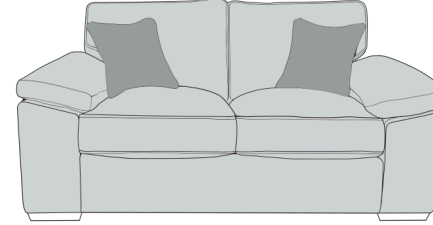

Love Chair (LOV)

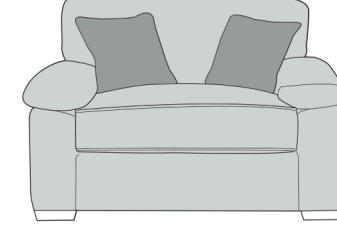

Arm Chair (1ST)

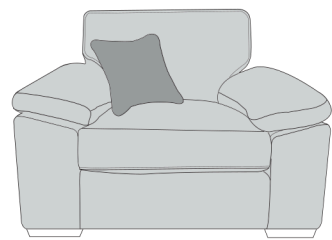

3 Seater Sofa Bed (3SB, 3DB)
(Available in Standard or Deluxe)

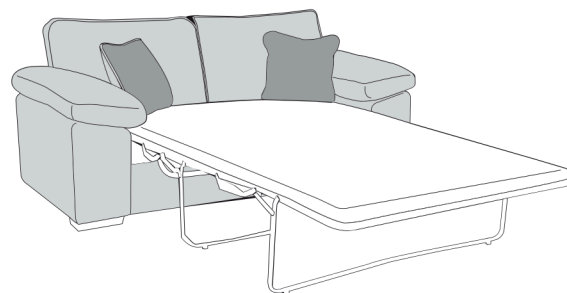

2 Seater Sofa Bed (2SB, 2DB)
(Available in Standard or Deluxe)

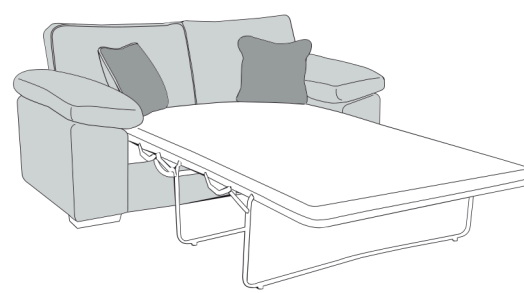

Chair Sofa Bed (1SB, 1DB)
(Available in Standard or Deluxe)

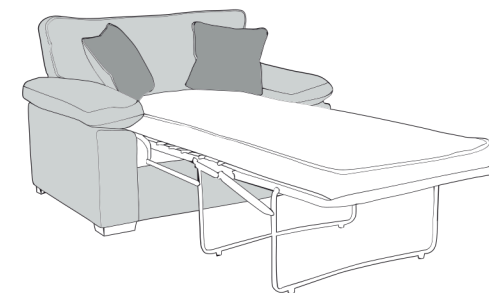

ACCENT PIECES

Storage Footstool (FSS)

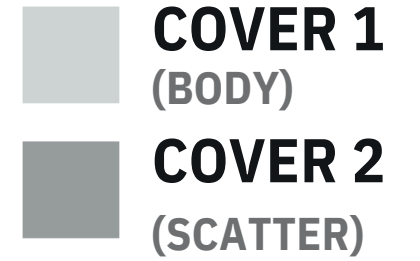
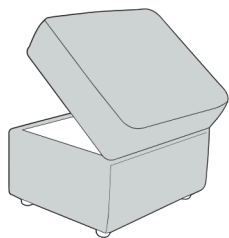

Scatter Cushions

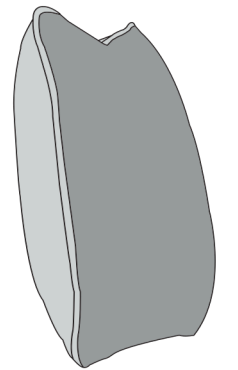

Front = Cover 2
Piping = Cover 1
Back = Cover 1



Dream DIMENSIONS (CM)

AVAILABLE PIECES	HEIGHT 1	WIDTH 2	DEPTH 3	SEAT HEIGHT 4	SEAT DEPTH 5	SEAT WIDTH 6	ACCESS DIAGONAL 7	OUTBACK HEIGHT 8	ARM HEIGHT 9	WEIGHT (KG)	SCATTER CUSHIONS
LH2, COR, RH2 GROUP	94	293	293	55	58	N/A	N/A	71	66	140.5	2
LH2, COR, RH1 GROUP or LH1, COR, RH2 GROUP	94	293	212	55	58	N/A	N/A	71	66	124.5	2
LH2, COR, R2V+VP GROUP or L2V+VP, COR, RH2 GROUP	94	293	293	55	58/109	N/A	N/A	71	66	148.5	2
LH1, COR, RH1 GROUP	94	212	212	55	58	N/A	N/A	71	66	108.5	2
CHAISE SOFA: 3RV, RFV	94	212	148	55	58/109	147	230	71	66	77	2
LH2/RH2 UNIT	94	189	97	55	58	151	208	71	66	53.5	1
LH1/RH1 UNIT	94	106	97	55	58	73	139	71	66	37.5	1
L2V+VP/R2V+VP UNIT	94	189	148	55	58/109	151	208	71	66	61.5	1
COR - CORNER UNIT	94	106	97	55	58	65	149	71	66	33.5	N/A
ALU - ARMLESS UNIT	94	80	97	55	58	80	122	71	66	21	N/A
3 SEATER SOFA (3ST)											
2 SEATER SOFA (2ST)											
LOVE CHAIR (LOV)											
ARM CHAIR (1ST)											
SOFA BEDS - STD BACK ONLY											
140CM STANDARD SOFA BED (3SB)											
120CM STANDARD SOFA BED (2SB)											
80CM STANDARD SOFA BED (1SB)											
140CM DELUXE SOFA BED (3DB)											
120CM DELUXE SOFA BED (2DB)											
80CM DELUXE SOFA BED (1DB)											
OPEN DEPTH OF SOFA BEDS 226CM											
ACCENT PIECES											
STORAGE FOOTSTOOL (FSS)											

* Hardwood & composite board frame.

* Dowelled, screwed, glued & stapled joinery.

* Light & Dark Wood foot options.

* ExtraFlex high comfort seat cushions.

* Fibre filled backs for added comfort.

* Serpentine seat & silent wire.

* Superloop back springs.

DIMENSION GUIDE

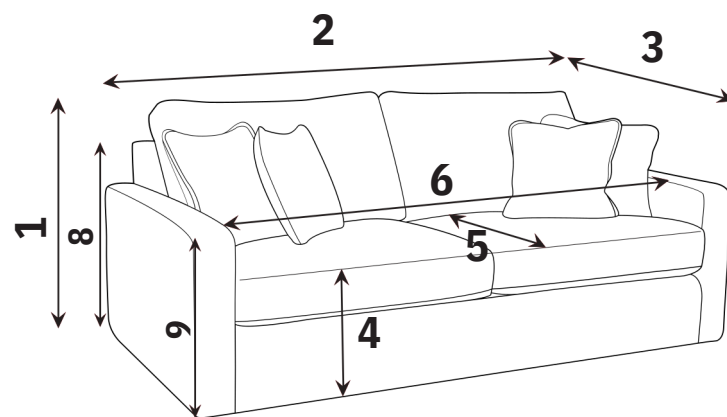

1 - HEIGHT
2 - WIDTH

3 - DEPTH
4 - SEAT HEIGHT

5 - SEAT DEPTH (STD & PILLOW)
6 - SEAT WIDTH

7 - DIAGONAL ACCESS
8 - OUTBACK HEIGHT
9 - ARM HEIGHT

Illustrations used for reference only.

Check the diagonal access dimension to ensure furniture will fit in your home.

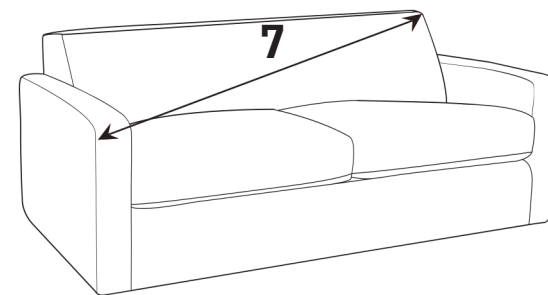

Extra Flex®

A high density foam base seat interior with a hand-rolled carded fibre, channelled topper which provides both softness and support.

CARE GUIDE

Extraflex seat cushions should be **plumped up on a regular basis** to help maintain the aesthetic appeal of your upholstery, the plumping of cushions is essential to help retain the comfort and softness of any piece of upholstered furniture.

To improve the longevity of your hand-made furniture, we recommend rotating cushions (where applicable).

For further information on maintaining your furniture please refer to the care guide located under the seat platform.

Beech (Light)

Mid Oak

Brown (dark)

FOOT OPTIONS:



Wood is a natural product and will vary in shade/colour from item to item.

SOFA BEDS: 2 SLEEP OPTIONS

STANDARD ACTION & FOAM MATTRESS

A three fold metal action with a sprung 'polyprop' base. Complemented by a high performance foam mattress. For occasional use only.

Mattress Thickness: 6cm

Mattress Length: 185cm

3 fold action is 140Kg total max occupancy weight

140cm sofa bed:

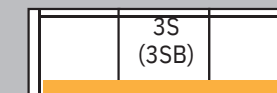

Mattress Width:133cm

120cm sofa bed:

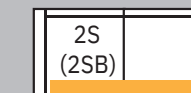

Mattress Width:113cm

80cm chair bed:

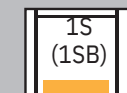

Mattress Width:73cm



DELUXE ACTION & SPRUNG MATTRESS

A two fold metal action with beech slats. Complemented by a deluxe sprung mattress. For everyday use.

Mattress thickness: 11.5cm

Mattress Length: 183cm

2 fold action is 160Kg total max occupancy weight

140cm sofa bed:

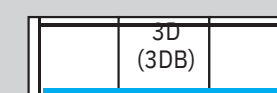

Mattress Width:132cm

120cm sofa bed:

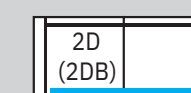

Mattress Width:114cm

80cm chair bed:

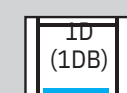

Mattress Width:76cm



Sofa beds available as standard back only

