

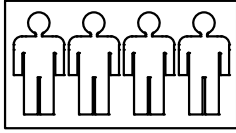

60 min



ASSEMBLY INSTRUCTION

ROUND DINING TABLE - REED

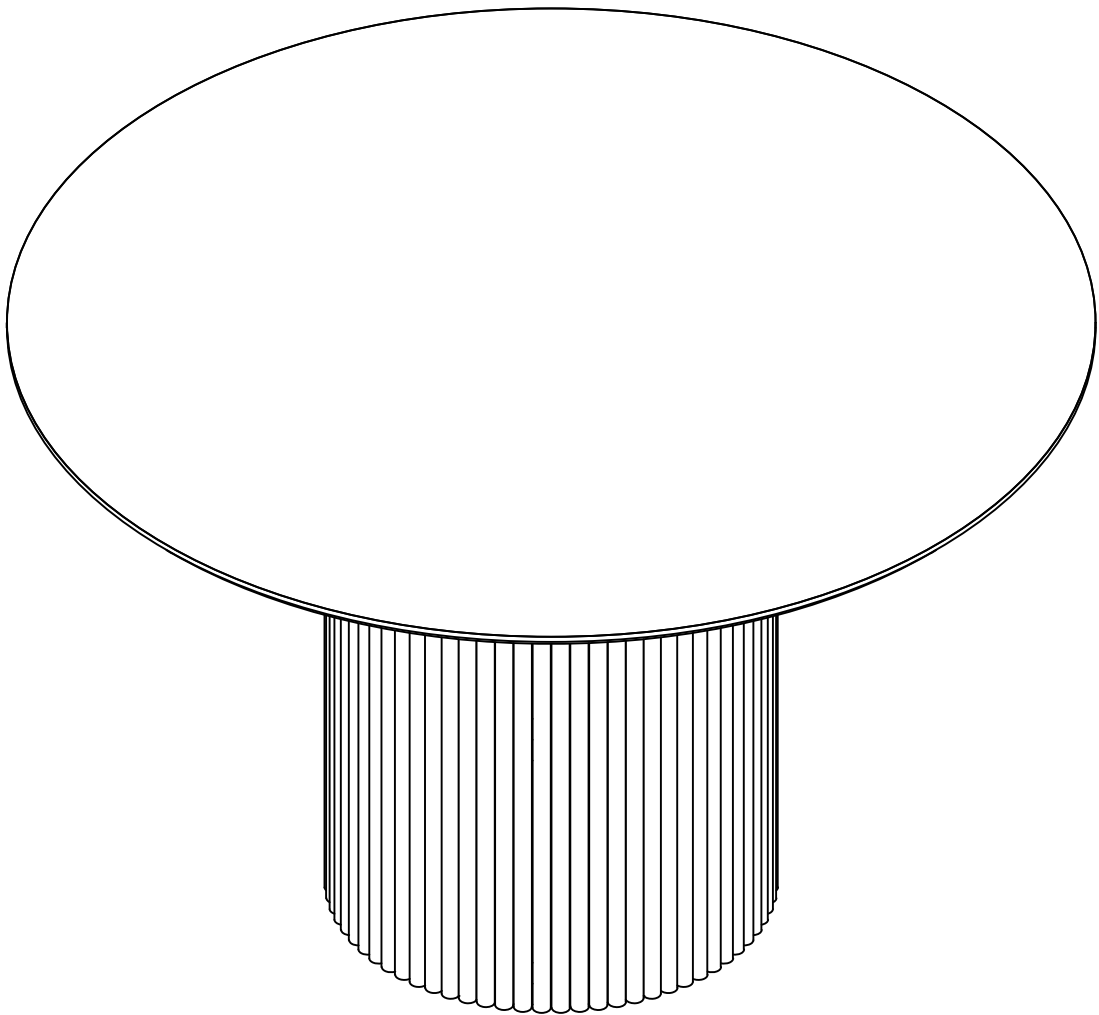

Marble and wood are both natural materials, across each piece you will be able to see and appreciate the unique markings and colours.

These natural features enhance the beauty and individuality of your furniture, they should not be considered as imperfections.

As a natural material wood will continue to move and be affected by its surroundings.

Changes in humidity and temperature can lead to warping and/or cracks in the wood.

Therefore, it is advisable not to place your furniture against a direct heat source or air conditioning unit.



Over time, with changes in the atmosphere and light, the wood will mellow.

To ensure an even tone we recommend that it is not left in direct sunlight and any objects placed on the furniture should be regularly moved around to help avoid colour differences.

Due to the weight of this item it is highly recommended that a minimum of 4 people are available to lift, turn and move the item into place.

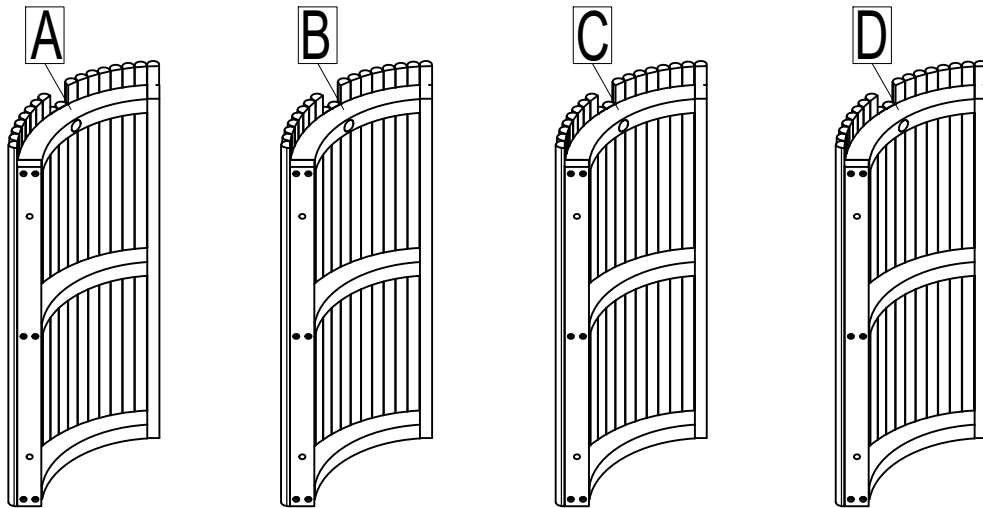
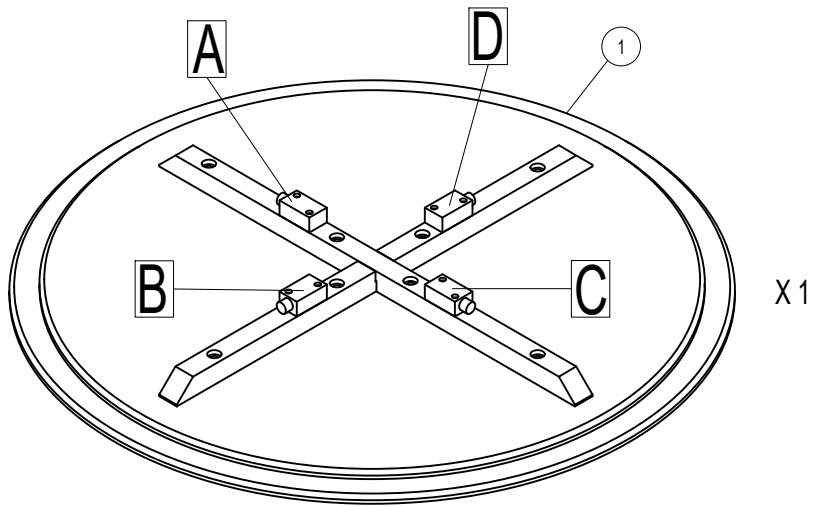
- Assemble the product in the room intended for use.
- Always lift your furniture to move it, never drag or push it as this can cause damage.
- Regularly check all fixings and tighten if necessary.
- For general care wipe with a soft, lint free cloth.
- For more stubborn marks, use a damp lint free cloth and buff with a dry, clean cloth.
- Wipe up spills immediately, never leave liquids sitting on the surface as this can damage the finish.
- Always use matts and coasters to protect the surface when in use.
- Never place hot items directly onto the surface.
- Do not use the surface as a chopping board.
- Do not use silicon-based furniture polish as the silicon can affect the finish.

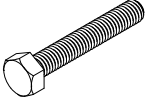
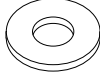

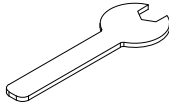

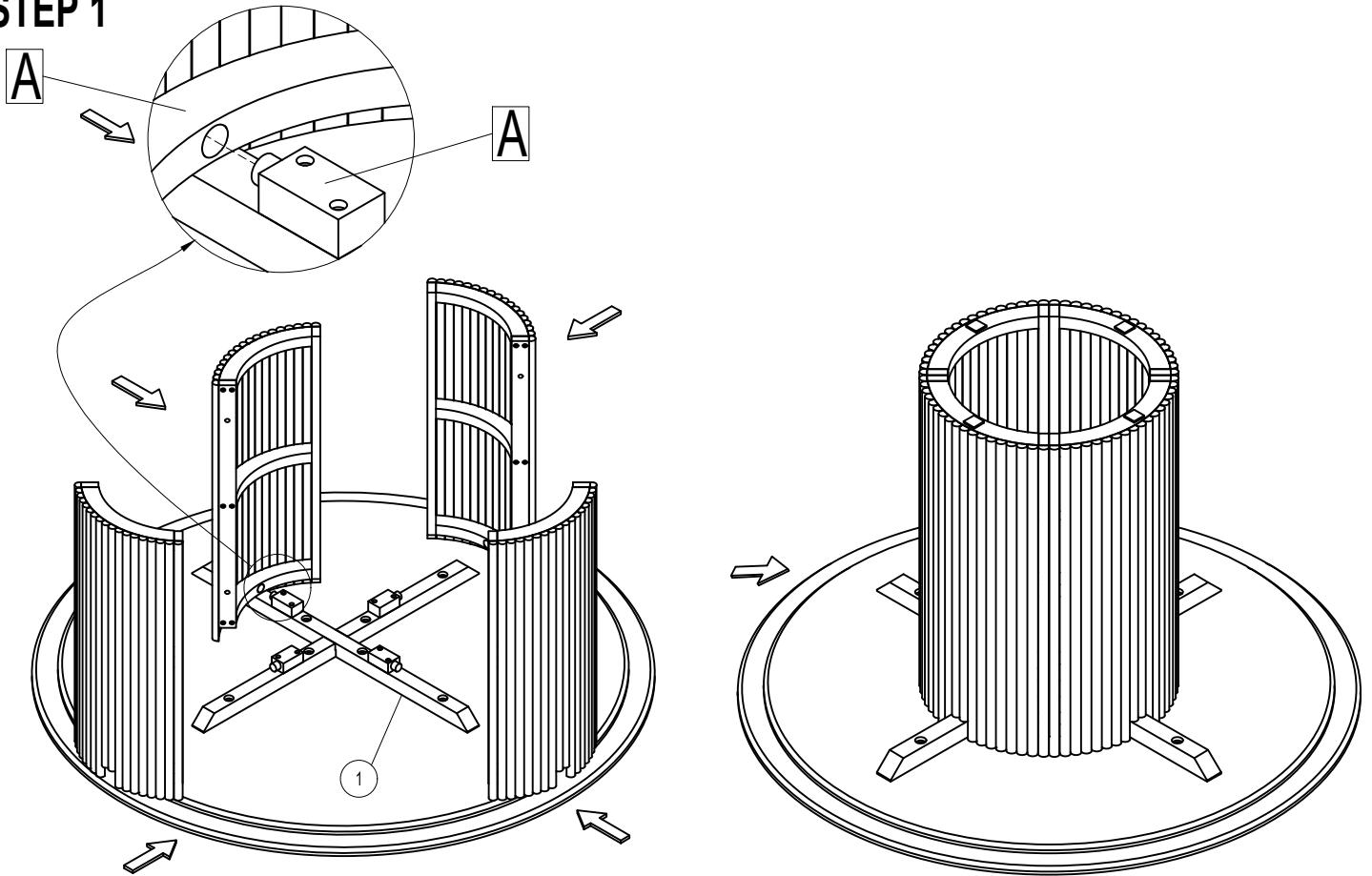

 <p>A x 8 M10 x 60</p>	 <p>B x 16 Ø20</p>	 <p>C x 16 Ø15</p>	 <p>D x 8 M10</p>	 <p>E x 2 V17</p>
--	--	--	---	--

STEP 1

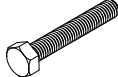

STEP 2

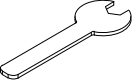
 A x 8 M10 x 60	 B x 16 Ø20	 C x 16 Ø15	 D x 8 M10	 E x 2 V17
---	---	---	--	--

